

AC180T

Portable Power Station

User Manual v1.0

Please read this manual carefully before use and keep it for future reference.



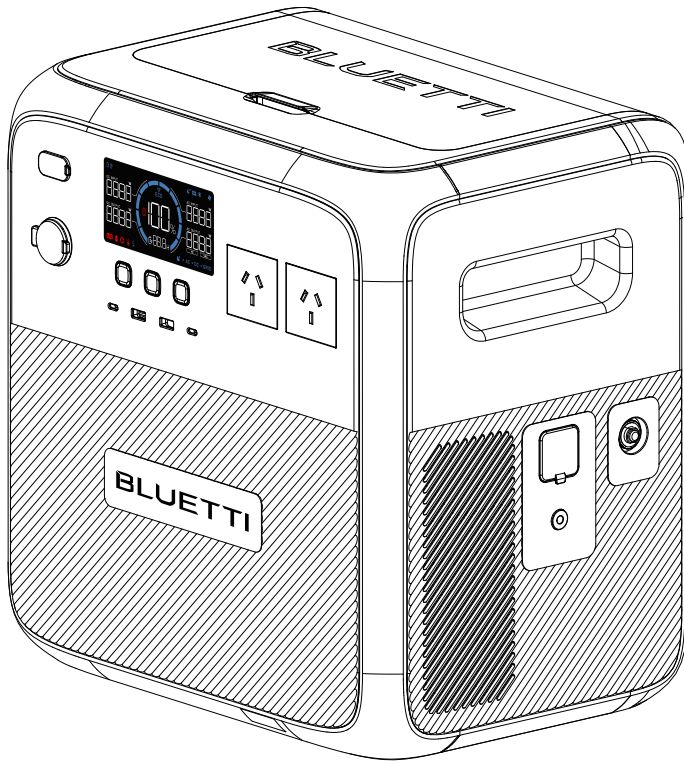

Warning

1. Charge the unit before first use.
2. Do not use solar panels with open circuit voltage higher than 60V. Solar input voltage range for the unit is 12V-60VDC.
3. Charge the unit immediately when the SoC drops below 5%. If the SoC drops to 0, power off the unit and charge it for at least 30 minutes before restarting.
4. The unit is for off-grid use only. Do not connect its AC output to the grid.
5. If not used for more than 3 months, charge the unit to 40%-60% SoC and store it with the power off. For optimum battery life, discharge and charge the unit every 3 months.

Thank You!

Thank you for making BLUETTI a part of your family.

From the very beginning, BLUETTI has tried to stay true to a sustainable future through green energy storage solutions while delivering an exceptional eco-friendly experience for our homes and our world.

That's why BLUETTI makes its presence in 100+ countries and is trusted by millions of customers across the globe.



Notice

BLUETTI's products, services, and features are subject to the agreed-upon terms and conditions during purchase. Please note that some products, services, or features described in this manual may not be available under your purchase contract. Unless otherwise specified in the contract, BLUETTI makes no representations or warranties of any kind, express or implied, with respect to the contents of this manual.

The contents of this manual are subject to change without notice. Please get the latest version from: <https://www.bluettipower.com/pages/user-guides>

If you have any questions or concerns about this manual, please contact BLUETTI support for further assistance.

Contents

1	Safety Instructions	05
2	Packing List	09
3	Product Introduction	11
4	Overview	12
5	Power ON / OFF	13
6	LCD Display	14
7	Charging.....	16
8	Discharging.....	18
9	Settings	19
10	BLUETTI App.....	21
11	Specifications.....	22
12	Button Operation Instructions.....	24
13	Troubleshooting.....	25
	Appx. 1 Estimating Operation Time.....	27
	Appx. 2 FAQ.....	28
	Appx. 3 Abbreviation.....	29

1. Safety Instructions

Read this manual for instructions on the proper use and safety information for the product. The safety instructions provided herein are for illustrative purposes that include but are not limited to those listed in this manual. Actual operation shall comply with all applicable safety standards. If you have any questions, feel free to contact BLUETTI support or your local BLUETTI dealers.

1.1 Statement

To ensure a safe operation, it's crucial to observe and adhere to the following conditions:

- Always operate or store the product in the conditions specified in this manual.
- Avoid unauthorized disassembly, component replacement, or modification of software codes.

 BLUETTI shall not be liable for damages resulting from the following circumstances:

- Force majeure events such as earthquakes, fires, storms, floods, or mudslides.
- Damage caused by the customer's own transportation.
- Damage resulting from inadequate storage conditions as specified in the manual.
- Damage caused by customer negligence, improper operation, or intentional actions.
- System or hardware damage caused by third parties or customers, including but not limited to improper handling and installation not in accordance with the instructions in this manual.
- Damage caused by adjustments, changes, or removal of identification labels not in compliance with this manual.

The product doesn't fulfill power supply needs for high-performance UPS equipment in critical sectors like atomic energy, aviation, medical, and other domains where safety is paramount. It's also not designed for power-reliant equipment. BLUETTI assumes no liability for incidents involving personal safety, fire, equipment malfunction, data loss, or any adverse aftermath resulting from using this product with such equipment.

1.2 General Requirements

INSTRUCTIONS PERTAINING TO RISK OF FIRE, ELECTRIC SHOCK, OR INJURY TO PERSONS
IMPORTANT SAFETY INSTRUCTIONS

WARNING:

When using this product, basic precautions should always be followed, including the following:

- Read all the instructions before using the product.
- Avoid contact with any liquids, do not use this product in the rain.

- To reduce the risk of injury, close supervision is necessary when the product is used near children.
- Do not put fingers or hands into the product. And do not insert foreign objects into any ports of the product.
- Use of an attachment not recommended or sold by the manufacturer may result in a risk of fire, electric shock, or injury to persons.
- To reduce the risk of damage to the electric plug and cord, pull the plug rather than the cord when disconnecting the product.
- Do not use a battery pack or appliance that is damaged or modified, as they may exhibit unpredictable behavior resulting in fire, explosion, or personal injury.
- Do not operate the product with a damaged cord or plug, or a damaged output cable.
- Do not attempt to disassemble or modify the battery or any other component of the product by anyone other than authorized personnel. There are no end-user serviceable components. Do not disassemble the product, take it to a qualified service person when service or repair is required. Incorrect reassembly may result in a risk of fire or electric shock.
- To reduce the risk of electric shock, unplug the product from the outlet before attempting any instructed servicing.
- **WARNING - RISK OF EXPLOSIVE GASES.** To reduce the risk of battery explosion, follow these instructions and those published by the battery manufacturer and manufacturer of any equipment you intend to use in the vicinity of the battery. Review cautionary markings on these products and engines.
- **PERSONAL PRECAUTIONS**
 - a. Wear complete eye protection and clothing protection. Avoid touching eyes while working near the battery.
 - b. Never smoke or allow a spark or flame in the vicinity of the battery or engine.
 - c. Be extra cautious to reduce the risk of dropping a metal tool onto the battery. It might spark or short-circuit the battery or other electrical parts which may cause an explosion.
- When charging the internal battery, work in a well ventilated area and do not restrict ventilation in any way.
- Under abusive conditions, liquid may be ejected from the battery; avoid contact. If contact accidentally occurs, flush with water. If liquid contacts eyes, additionally seek medical help. Liquid ejected from the battery may cause irritation or burns.
- Do not expose the product to fire or excessive temperature. Exposure to fire or temperature above 80°C (176°F) may cause an explosion.
- Have servicing performed by a qualified repair person using only identical replacement

parts. This will ensure that safety is maintained.

- Do not stack anything on top of the product while in storage or use. Do not move the product while operating as vibrations and sudden impacts may lead to poor connections to the hardware inside.
- In case of fire, use only a dry powder fire extinguisher appropriate for the product.
- **WARNING - RISK OF ELECTRIC SHOCK.** Never use the product to supply power tools to cut or access live parts or live wirings, or materials that may contain live parts or live wirings inside, such as building walls, etc.
- Only use the detachable battery with the specified BLUETTI products.

1.3 Grounding Instructions

The product is designed for portable use and typically does not require earth grounding. However, if you connect it to the power grid, it's important to ensure proper grounding for safety. If it should malfunction or break down, grounding provides a path of least resistance for electric current to reduce the risk of electric shock. This product is equipped with an AC power cord having an equipment-grounding conductor and a grounding plug. The plug must be plugged into an outlet that is properly installed and grounded in accordance with all local codes and ordinances.

WARNING:

Improper connection of the equipment-grounding conductor can result in a risk of electric shock. Check with a qualified electrician if you are in doubt as to whether the product is properly grounded. Do not modify the plug provided with the product - if it does not fit the outlet, have a proper outlet installed by a qualified electrician.

1.4 Handling Requirements

During transportation or storage, take care to avoid dropping, violently impacting, or tilting the product as it may result in internal damage. If necessary, use mechanical assistance such as carts or adjustable height workbenches to ensure safe handling.

Recommended number of people based on the weight of product

Weight	Number of people
<18kg (39.7lbs)	1
18kg~32kg (39.7lbs~70.5lbs)	2
32kg~55kg (70.5lbs~121.3lbs)	3
>55kg (121.3lbs)	4 or a cart

1.5 Storage Instructions

- When the SoC drops to 5%, please charge the product immediately.

- Before storing the product, charge it to 40% to 60% SoC to keep it in optimal condition. In addition, power off the product and disconnect all electrical connections from it.
- Store the product in a cool and dry place, keeping it away from flammable or combustible materials and gases.
- The product can be safely stored within a temperature range of -20°C to 40°C (-4°F to 104°F). However, if the storage duration exceeds one month, it's recommended to maintain an ideal storage temperature of around 30°C (86°F).
- Fully cycle the product every 3 months to maintain the battery's health. It's NOT recommended to store the product for extended periods of time, as it may affect its performance and overall lifespan.

If the SoC drops to 0 (during storage or upon startup), take the following actions to safely restart the product:

- Shut down immediately.
- Charge within 48 hours.
- Keep it at an ambient temperature of 5°C to 35°C (41°F to 95°F) for 6 hours before charging. It's recommended to charge the product via an AC source. If charging via solar energy, ensure that your solar system provides an output of more than 100W.

 The symbol displayed is intended to remind you to read the instructions in the literature accompanying the product before operation and maintenance.





- Connect the product to a socket-outlet that has an earthing connection using the power cord provided.
- The socket-outlet should be installed near the product and easily accessible for safety purposes.
- Never dispose of a battery by throwing it into fire or a hot oven, or by mechanically crushing or cutting it, as these may cause it to explode.
- Avoid leaving batteries in extremely high-temperature environments, as this can result in an explosion or the leakage of flammable liquid or gas.
- The battery subjected to extremely low air pressure may result in an explosion or the leakage of flammable liquid or gas.
- Attention should be drawn to the environmental aspects of battery disposal.
- Please refer to the information on the exterior bottom enclosure for electrical and safety information before installing or operating the apparatus.

SAVE THESE INSTRUCTIONS

 **BLUETTI shall not be liable for any equipment damage caused by the violation of the above instructions.**

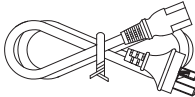
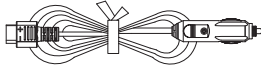
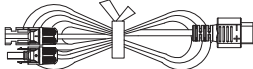
2. Packing List

Standard Accessories

Item	Picture	Qty.
AC180T Portable Power Station		1
AC Charging Cable		1
Car Charging Cable		1
Solar Charging Cable		1
Grounding Screws		1
User Manual		1
Warranty Card		1

Optional Accessories

(Available on the official BLUETTI website: <https://www.bluettipower.com>)

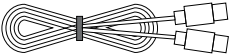
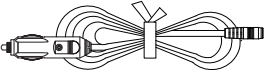
Item	Picture
USB-C to USB-C Cable (output)	
12V DC Power Cable (For 12V devices with DC5521 port, such as routers, cameras, etc.)	

3. Product Introduction

Meet the BLUETTI AC180T portable power station - a cutting-edge energy solution that supercharges your mobile power experience. It's got a robust 1,800W inverter and two 716.8Wh LiFePO₄ batteries to give you plenty of power for your journeys.

The AC180T delivers up to 1,800W of AC output and a maximum combined AC+DC output of 1,900W. If your total power demand exceeds 1,900W, yet the AC loads stay below 1,800W, the AC180T intelligently turns off the DC output while maintaining the AC output. In addition, with Power Lifting Mode enabled, you can effortlessly manage heating devices up to 2,700W, including hairdryers and heaters. (See the "Settings" section for details.)

A single battery reaches 80% charge in just 48 minutes; with two batteries, it takes only 60 minutes. Plus, it can use sunlight simultaneously to charge up faster when you're far away from an outlet.

Danger:

Do not connect the AC output of AC180T to the grid.

4. Overview

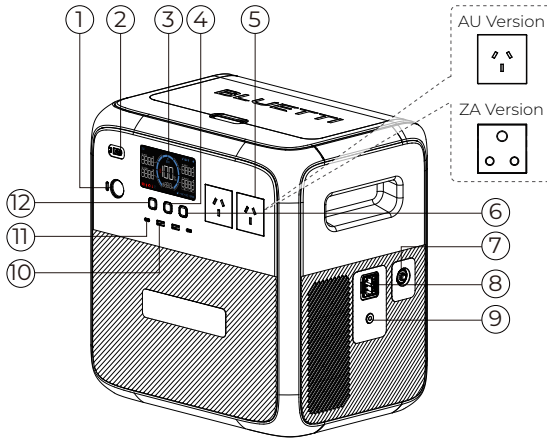

- | | | |
|--------------------------|-------------------|-------------------|
| ① Cigarette Lighter Port | ⑤ AC Outlet | ⑨ Grounding Pole |
| ② DC/PV Input | ⑥ AC Power Button | ⑩ USB-A Port |
| ③ LCD Display | ⑦ Breaker | ⑪ USB-C Port |
| ④ POWER Button | ⑧ AC Input | ⑫ DC Power Button |

4.1 Detachable Battery Overview

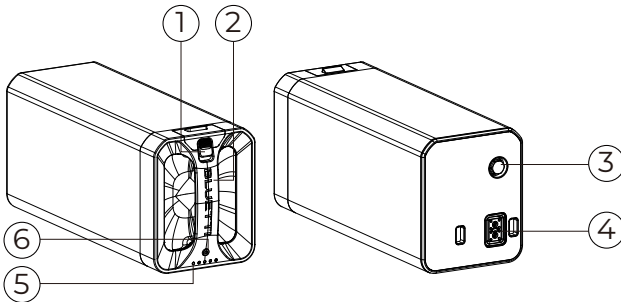

- | | |
|---------------|--|
| ① Latch | ④ Charging Port |
| ② Handle | ⑤ Battery Indicator (1 light for 20% charge) |
| ③ Bleed Valve | ⑥ Power Button |

5. Power ON / OFF

Attention:

Please place the unit on the platform firmly and stably.

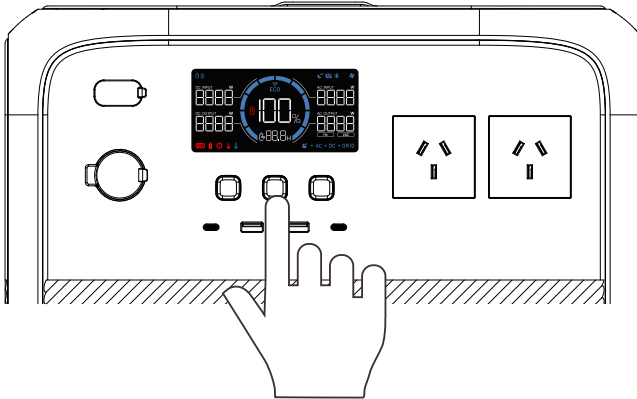

- Power ON: Press the POWER Button to turn on.
- Power OFF: Press and hold the POWER Button for about 2 seconds to turn off.
- AC ON / OFF: When the AC180T is on, press the AC Power Button to turn it on / off.
- DC ON / OFF: When the AC180T is on, press the DC Power Button to turn it on / off.
- Restart: Power off the AC180T first, then press the POWER Button to restart.





























Note: When the AC180T is on, you can activate the LCD display by interacting with any of the buttons. When AC and DC is off for more than 1 minute, the AC180T will be off automatically.

6. LCD Display

The AC180T features an informative LCD display that offers easy access to all the essential information about the unit's status and performance. When you power on the unit, the LCD display lights up, and when you power off the unit, the display turns off as well.



- | | | |
|------------------------|-------------------------------------|-------------------------------|
| ① Battery Connection | ⑪ Grid Connection | ⑳ Overload Alert |
| ② Silent Charging | ⑫ DC Output | ㉑ Fault Alert |
| ③ DC/PV Input | ⑬ AC Output | ㉒ DC Output Power |
| ④ Bluetooth Connection | ⑭ Power Lifting Mode | ㉓ Low Battery Alert |
| ⑤ Fan Status | ⑮ Charge / Discharge Remaining Time | ㉔ Battery Capacity (SoC) |
| ⑥ Turbo Charging | ⑯ Charge / Discharge Status | ㉕ DC Input Power |
| ⑦ AC Input Power | ⑰ Low Temperature Alert | ㉖ ECO Mode |
| ⑧ AC Output Power | ⑱ High Temperature Alert | ㉗ Charge / Discharge Progress |
| ⑨ AC Output Voltage | ㉑ Overcurrent Alert | |
| ⑩ AC Output Frequency | | |

LCD Instructions	
Startup	LCD lights up
Shutdown	LCD lights off
Each icon represents a detachable battery. The AC180T can display up to 2 battery icons.	
The AC180T is charging in Silent Charging Mode.	
The AC180T is charging from a DC power source, such as solar panels, lead-acid batteries, etc.	
The AC180T connects to BLUETTI App via Bluetooth.	
When it lights up, the fan is activated and working properly. If it flashes, there may be a problem with the fan.	
The AC180T is charging in Turbo Charging Mode.	
The real-time AC charging power.	
The real-time total AC output power.	
The real-time AC output voltage.	
The real-time AC output frequency.	
The AC180T is charging from the home grid.	
The DC output is turned on.	
The AC output is turned on.	
The AC180T is operating in Power Lifting Mode.	
The remaining time of charging or discharging.	
 : Charging  : Discharging	
The temperature inside the unit is too low.	
The temperature inside the unit is too high.	
The AC180T is drawing too much current, which can cause damage to the unit or any connected devices.	
The AC180T is overloaded.	
There's an issue with the AC180T, which may require troubleshooting or repair.	
The real-time DC output power.	
The SoC drops below 5%.	
The remaining battery capacity. If it flashes, the charge levels of the two batteries are different.	
The real-time DC input power.	
The ECO Mode is activated to save power.	
The bar increases during charging and decreases during discharging.	

7. Charging

AC180T supports four charging methods: AC, solar, car, and generator.

⚠ Attention:

- Double-check that all cables are firmly plugged in.
- Avoid getting the plug and socket wet to prevent any potential damage.

7.1 AC Charging

Plug the AC180T into a standard wall outlet and start charging. Once it's fully charged, the AC180T automatically stops charging to prevent overcharging. For a fast charge, you can enable Turbo Charging in the BLUETTI App, which allows for an 80% capacity in just 48 minutes at an ambient temperature of 25°C (77°F).

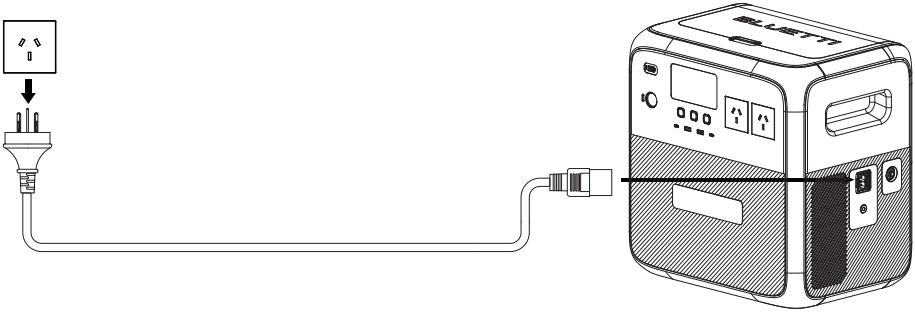

7.2 Solar Charging

Connect the solar panels (in series or parallel) to AC180T via the solar charging cable. When receiving a continuous input of 500W, the AC180T will automatically stop charging after 2 hours with 1 battery or 4 hours with 2 batteries. However, please be aware that the charging time may vary based on weather conditions, sunlight intensity, panel orientation, and other variables.

Note: Make sure your solar panel(s) meet the following requirements:

Voc: 12V-60V Current: 10A Max. Power: 500W Max.

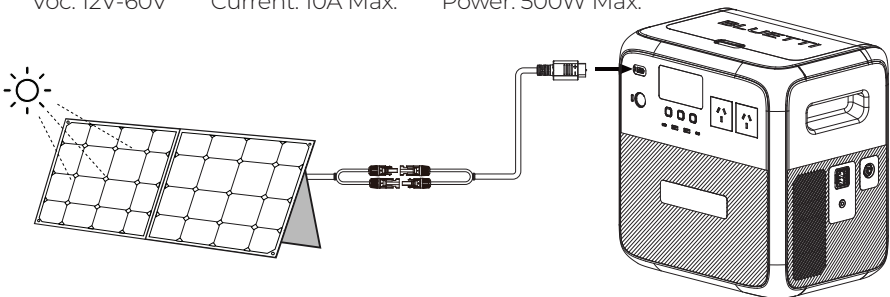

7.3 Car Charging

Connect AC180T to the vehicle's 12V or 24V cigarette lighter port via the car charging cable. The AC180T can charge at a maximum rate of 96W when connected to a 12V port and 192W when connected to a 24V port. Once it reaches full charge, it'll automatically stop charging.

Note: Make sure your vehicle meets the following conditions for charging:

- The vehicle is capable of supplying power.
- The vehicle's engine is running during the charging process.

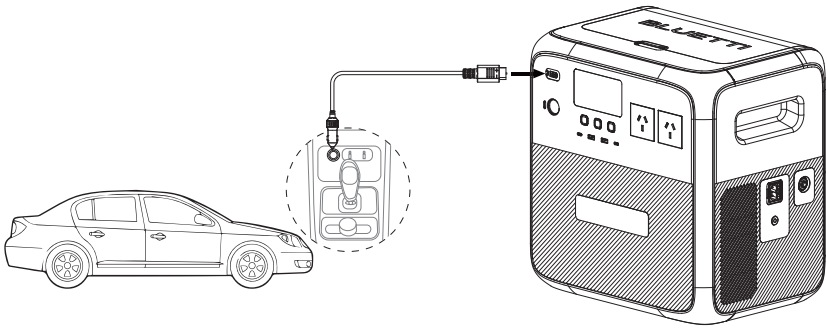

7.4 Generator Charging

Connect the AC180T to a generator via the AC charging cable. The AC180T also automatically stops charging when it's fully charged.

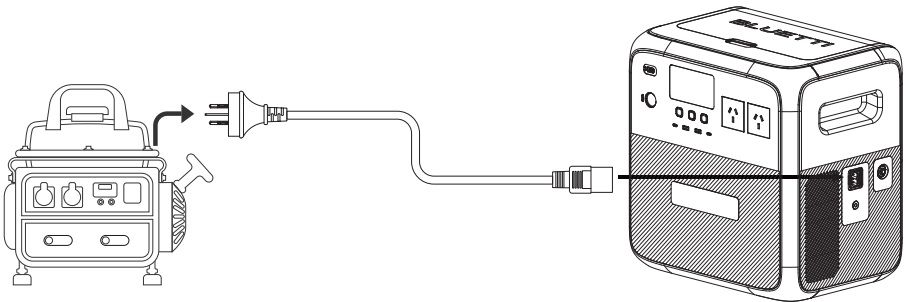

Note: Make sure your generator delivers the AC output with charging voltage and frequency that meet AC180T's specifications.



If the total power demand of your connected devices exceeds the generator's output capacity, please turn on the Grid Self-adaption Mode to ensure a seamless charging experience.

8. Discharging

8.1 AC Discharging

Port	Specifications	Description
AC Outlet x 2	230V 50Hz / 60Hz	Appliances up to 1,800W power.

8.2 DC Discharging

Port	Picture	Specifications	Description
Cigarette Lighter Port x 1		12V / 10A	12V DC appliances up to 120W power. e.g. car refrigerator, air conditioner
USB-A x 2		5V / 3A	Mobile phones and other small loads.
USB-C x 2		5/9/12/15/20V, 3A; 20V / 5A	Mobile phones, laptops, etc.

Note: To ensure optimal performance, avoid short-circuiting the ports and keep them dry during use or storage. Additionally, do not block or cover the ports while ensuring proper ventilation.

9. Settings

The AC180T offers the convenience of adjusting its settings either via physical buttons or the BLUETTI App. With the buttons located on the device itself, you have direct control over various settings such as ECO Mode, output frequency, charging modes, and other functionalities. Additionally, by using the BLUETTI App, you can access a user-friendly interface on your phone to conveniently monitor and control the AC180T.

9.1 Setting Mode

When the AC180T is powered on, press and hold the AC and DC Power Buttons for more than 1 second till the output frequency flashes to enter the Setting Mode.

9.2 ECO Mode

The AC180T has two ECO modes that help you save power and extend battery life:

- AC-ECO Mode

In this mode, if the AC power output falls below or remains at a certain level for a set period of time, the AC power will automatically turn off.

- DC-ECO Mode

In this mode, if the DC power output falls below or remains at a certain level for a set period of time, the DC power will automatically turn off.

Attention:

- The AC-ECO and DC-ECO modes are enabled by default to save energy, and it's recommended to keep them enabled at all times.
- Use the BLUETTI App to enable or disable AC-ECO Mode and DC-ECO Mode separately. If you use the LCD display, they'll be turned on or off at the same time.
- To avoid any interruption in charging, disable ECO Mode when charging small devices that consume less power than the set power limit.

In the Setting Mode, press the DC Power Button to navigate through the setting items. When the **ECO** icon flashes on the display, press the AC Power Button to enable or disable the ECO Mode.

9.3 Frequency Switching

The current output frequency (50Hz / 60Hz) is displayed in the lower right corner of the display. Before making any changes, ensure that the AC output is turned off. Then, access the Setting Mode and press the AC Power Button to switch the frequency options.



9.4 Power Lifting Mode



The Power Lifting Mode is specifically designed to handle resistive loads up to 2,700W, including electric blankets, kettles, hairdryers, and other heating devices. To enable or disable it, access the Setting Mode, navigate with the DC Power Button until the  starts flashing on the screen, and press the AC Power Button.

Note: The Power Lifting Mode is not enabled by default and is only suitable for resistive loads with a power rating between 1,800W-2,700W.

Although the AC180T can handle higher power demands, its actual operating power remains at 1,800W.

9.5 AC Charging Mode

The AC180T supports 3 AC charging modes - Standard, Turbo, and Silent to fit your specific needs. In the Setting Mode, use the DC power button to navigate until the  or  icon starts flashing on the screen. Then, press the AC power button to choose the charging modes.

Icon	Mode	Recharging Power		Recharging Time	Note
		w/ 1 pack	w/2 packs		
None	Standard	450W	900W	2 hours	Reduces battery wear and tear for long battery life.
	Turbo	850W	1440W	1.5 hours 0-80% in 48 mins	Comes in handy when recharging time is a priority.
	Silent	360W Max.	720W Max.	4 hours	Offers a quiet, low-power operation.

9.6 Bluetooth On / Off

To connect the AC180T to the BLUETTI App, turn on the Bluetooth first. In the Setting Mode, press the DC Power button to navigate through the setting items. When the  icon flashes on the screen, press the AC Power Button to turn Bluetooth on / off.

9.7 Grid Self-adaption Mode

If you're charging the AC180T using a generator or unstable grid voltage, and the total power demand of your connected devices exceeds the AC180T's input power, it is recommended that you enable the Grid Self-adaption Mode through the BLUETTI App to ensure a stable, safe charging experience for both the AC180T and your devices.

9.8 Exit Setting Mode

To save your AC180T settings and exit the Setting Mode, press and hold both the AC and DC Power Buttons at the same time.

Note: If you do not perform any operation in 1 minute, the AC180T will automatically exit the Setting Mode, and no changes will be saved.

10. BLUETTI App

Scan the QR code below or search "BLUETTI" in the App Store or Google Play to download the BLUETTI App.







For more details, please refer to BLUETTI APP INSTRUCTIONS.

11. Specifications

Model (Country / Region)	AC180T (JP)	AC180T (US)	AC180T (CN)	AC180T (EU)	AC180T (AU)
Battery Capacity	(716.8Wh / 28Ah)×2pcs				
Cell Type	Lithium Iron Phosphate (LiFePO ₄ , LFP)				
AC + DC Input	1,940W Max.				
Weight	AC180T: 26.5kg / 58.4lbs (w/ 2 batteries) Battery: 8.5kg / 18.7lbs				
Dimensions (L × W × H)	AC180T: 390mm × 280mm × 395mm / 15.4in × 11.0in × 15.6in Battery: 134mm × 160mm × 350mm / 5.3in × 6.3in × 13.8in				
Charging Temperature	0°C to 40°C / 32°F to 104°F				
Discharging Temperature	-20°C to 40°C / -4°F to 104°F				
Storage Temperature	-20°C to 40°C / -4°F to 104°F				
Working Humidity	10% to 90%				
AC Output					
Power	1,800W (with 2 batteries or with Grid) 1,200W (with 1 battery and without Grid)				
Surge Power	3600W@1s				
Overload Power	1260W~1440W@120s / 1440W~1800W@10s / 1800W~2400W@1s				
Voltage	100V	120V	220V	230V	
Current	18A	15A	8.2A	7.8A	
Frequency	50Hz / 60Hz				
DC Output					
Cigarette Lighter Port × 1	12V / 10A				
USB-A × 2	5V / 3A				
USB-C × 2	5 / 9 / 12 / 15 / 20V, 3A; 20V / 5A				
DC Output Power	365W Max.				
AC Input					
Voltage	100V	120V	220V	230V	
Charging Current	14.4A Max.	12A Max.	6.6A Max.	6.3A Max.	
Input Current	15A Max.	15A Max.	9.3A Max.	9A Max.	
Frequency	50Hz / 60Hz				
UPS	Switching time ≤20ms				
Charging Power	1,440W Max. (w/ 2 batteries) 850W Max. (w/ 1 battery)				











DC Input	
Interface	XT60PM-M
Power	500W Max.
Current	10A Max.
Voltage	12V to 60V
Other Parameters	
AC + DC/PV Charging Power	1,940W Max. (w/ 2 batteries)
	1080W Max. (w/1 battery)
AC + DC Output Power (without GRID)	1,900W Max. (w/ 2 batteries)
	1200W Max. (w/1 battery)





12. Button Operation Instructions

Operation	Function	Description
Press the AC Power Button	Turn on / off the AC output	/
Press the DC power button	Turn on / off the DC output	/
Press the AC and DC Power Buttons simultaneously and hold for more than 1 seconds till the output frequency flashes	Enter / exit the Setting Mode	In the Setting Mode, the icons for the currently enabled functions remain lit, except for the flashing output frequency icon. If you do not perform any operation in 1 minute, the AC180T will automatically exit the Setting Mode, and no changes will be saved.
Press the DC Power Button in the Setting Mode	Navigate through the setting items	The flashing setting item is selected and editable. In the Setting Mode, the corresponding codes will be displayed on the left side: P01: Output Frequency P03: Charging Mode P04: Power Lifting Mode P05: ECO Mode P06: Bluetooth
Press the AC Power Button when the setting item is flashing	Enable or disable the selected function.	/
Press and hold the DC Power Button in the Setting Mode	Switch the status page	You can view relevant information on the status page.  : Serial Number  : Error code  : Historical faults  : Version

13. Troubleshooting

In the Setting Mode, press and hold the DC Power Button for more than 2 seconds until the error code appears on the display. Please refer to the table below for helpful guidance.

Error Code	Alarm Icon	Description	Troubleshooting
E001		Inverter overload	Check if the power consumption of your devices is too high. Reduce the load if necessary.
E002		Inverter overtemperature protection, AC output off	Wait for about 10 minutes until the unit cools down, then turn on the AC output again.
E003		Inverter short circuit	1.Check if the power consumption of your devices is too high. 2.Check if any of your electrical devices are causing a short circuit.
E033		PV overvoltage	Make sure the PV input voltage is within the range of 12V to 60VDC.
E039		PV overtemperature	Wait for about 10 minutes until the unit cools down, then re-enable the PV input.
E065		DC output short circuit	1.Check if the power consumption of your devices is too high. 2.Check if any of your electrical devices are causing a short circuit.
E067		DC output overcurrent	Check if the power consumption of your devices is too high. Reduce the load if necessary.
E068		DC output overtemperature	Wait for about 10 minutes until the unit cools down, then restart your devices.
E085		Charging temperature too high	Wait for the unit to cool down before charging.
E086		Charging temperature too low	Make sure the unit is placed in an ambient temperature of 0°C to 40°C (32°F to 104°F).
E087		Discharging temperature too high	Wait for the unit to cool down before discharging.

E088		Discharging temperature too low	Make sure the unit is placed in an ambient temperature of -20°C to 40°C (-4°F to 104°F).
E113	 flashes	Grid overvoltage	Check if the grid voltage is too high. Change the input source if necessary.
E114	 flashes	Grid undervoltage	Check if the grid voltage is too low. Change the input source if necessary.
E115	 flashes	Grid overfrequency	Check if the grid frequency is too high. Contact your local power provider if necessary.
E116	 flashes	Grid underfrequency	Check if the grid frequency is too low. Contact your local power provider if necessary.
Others	/	/	Please contact BLUETTI support for assistance.

Appx. 1 Estimating Operation Time

To estimate the operation time of the AC180T, consider the load you're applying:

· For high-power loads (above 300W):

Operation time = Battery Capacity (Wh) x DoD x η ÷ Load Power

· For small-power loads (below 300W):

Operation time = Battery Capacity (Wh) x DoD x η ÷ (Load Power + AC180T Self-consumption)

Note: DoD refers to the depth of discharge. AC180T works at 90% DoD for longer battery life.

η is the conversion efficiency of the inverter, typically over 90% for AC180T.

The self-consumption of AC180T is approximately 15W.

E.g. If you have a 65W refrigerator, you can run it for about 14 hours.

Operation time = (716.8 x 2) Wh x 90% x 90% ÷ (65W + 15W) ≈ 14 hours.

Please keep in mind that the estimated operation time provided is for reference purposes and may vary based on actual usage conditions. Factors such as low temperature and excessive loads can significantly affect the battery capacity, leading to a reduction in the average operation time.

Appx. 2 FAQ

Q1: How do I know whether my devices will work well with this product?

A: Please evaluate the total constant load of your devices. If it doesn't exceed the Max. output power of AC180T (1,800W with 2 batteries or 1,200W with 1 battery), you can use this power station to run your devices.

Note: Some devices with built-in motors or compressors may start at 2-4 times the rated power, which can easily overload the AC180T.

Q2: Can I use third-party solar panels to charge this product?

A: Yes, you can. However, make sure your solar panels have an open circuit voltage of 12V-60V and are equipped with MC4 connectors. It's also important not to mix different types of solar panels.

Q3: Can it charge and discharge at the same time?

A: Yes. It supports pass-through charging. The AC180T comes with the premium LiFePO₄ battery and proprietary Battery Management System to ensure that it can charge and discharge at the same time.

Q4: Why is the charging power often too low?

A: AC180T has a built-in intelligent BMS that automatically adjusts the charging power in response to the battery temperature and SoC, thus protecting the battery and extending its service life.

Appx. 3 Abbreviation

- MPPT: Maximum Power Point Tracking
- SoC: State of Charge
- UPS: Uninterruptible Power Supply
- AC: Alternating Current
- DC: Direct Current
- PV: Photovoltaic
- DoD: Depth of Discharge

For more information, please visit:



@ BLUETTI Support

@BLUETTI Official



@bluetti_official



@ bluetti.inc



@ bluetti_inc



sale-au@bluettipower.com

Customer Service(AU)

Email: sale-au@bluettipower.com

Address: Unit 15, 25 Gibbes Street Chatswood NSW 2067

Customer Service(ZA)

Email: sale-za@bluettipower.com

SHENZHEN POWEROAK NEWENER CO., LTD.

Address: F19, BLD No.1, Kaidaer, Tongsha Rd No.168,

Xili Street, Nanshan, Shenzhen, China

Web: <https://www.bluettipower.com>





BLUETTI

「 」

「 」

Certificate

Inspector: _____

QC: _____

Just Power On